

- COUNTY LINE
- CORPORATE LIMITS
- STATE TRUNKLINE
- COUNTY PRIMARY
- COUNTY LOCAL
- AJACENT COUNTY
- CITY OR VILLAGE STREETS

PRIMARY ROAD SYSTEM IS 8.69 MILES
 LOCAL ROAD SYSTEM IS 14.13 MILES

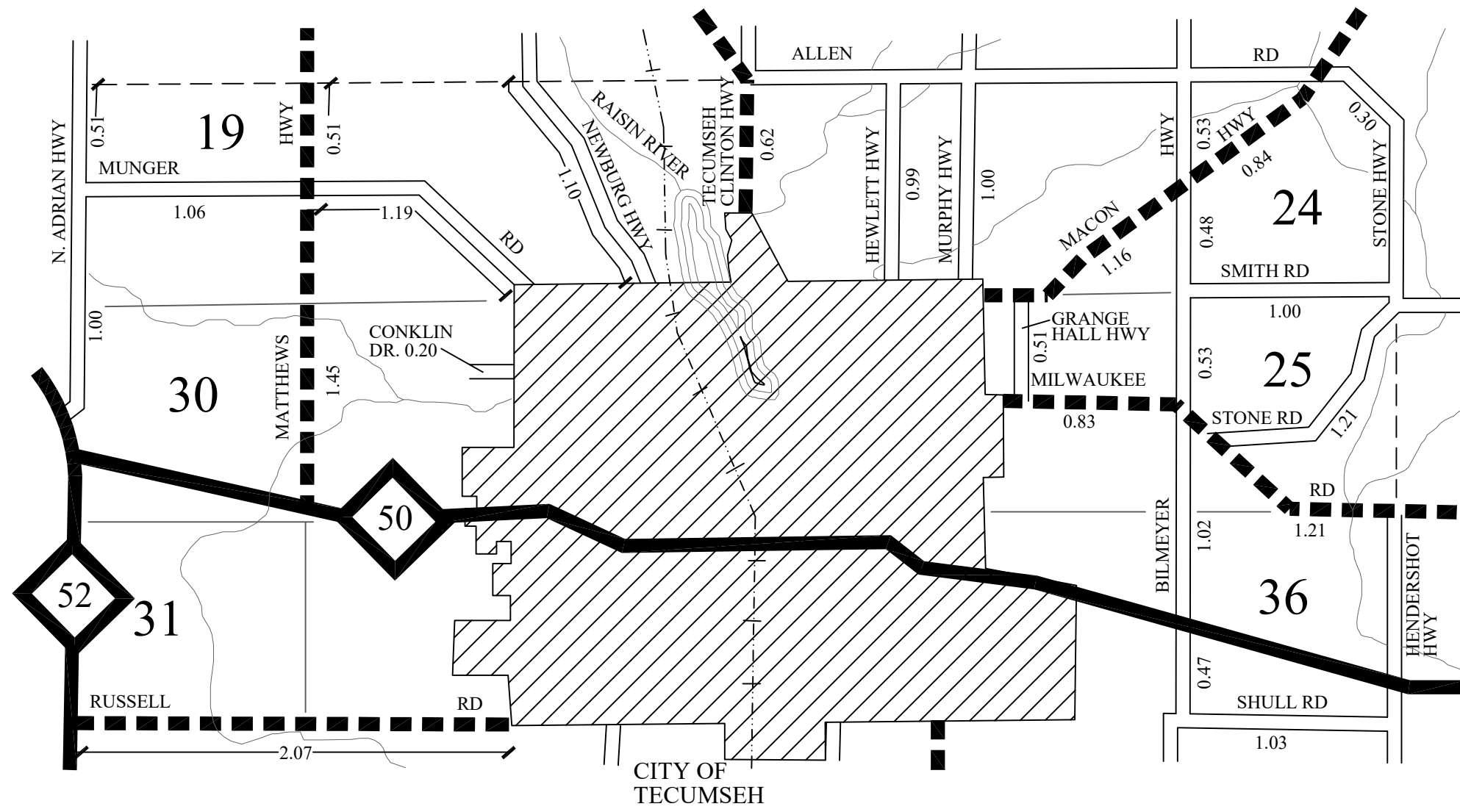

TECUMSEH TWP

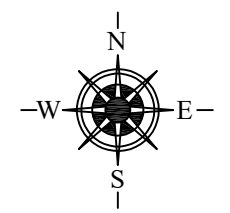

- COUNTY LINE
- CORPORATE LIMITS
- STATE TRUNKLINE
- COUNTY PRIMARY
- COUNTY LOCAL
- AJACENT COUNTY
- CITY OR VILLAGE STREETS

TOTAL FEET 14,571 EQUALS 2.76 MILES

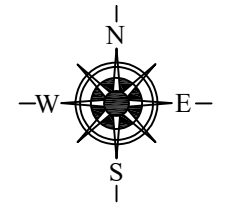
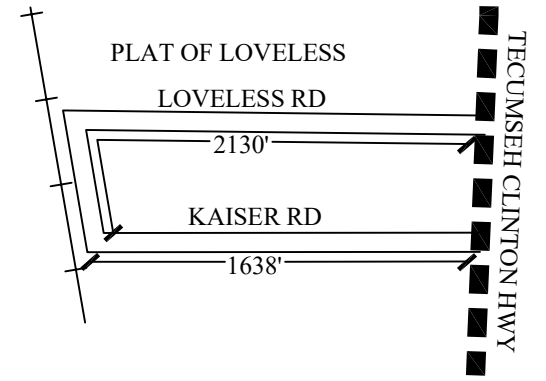
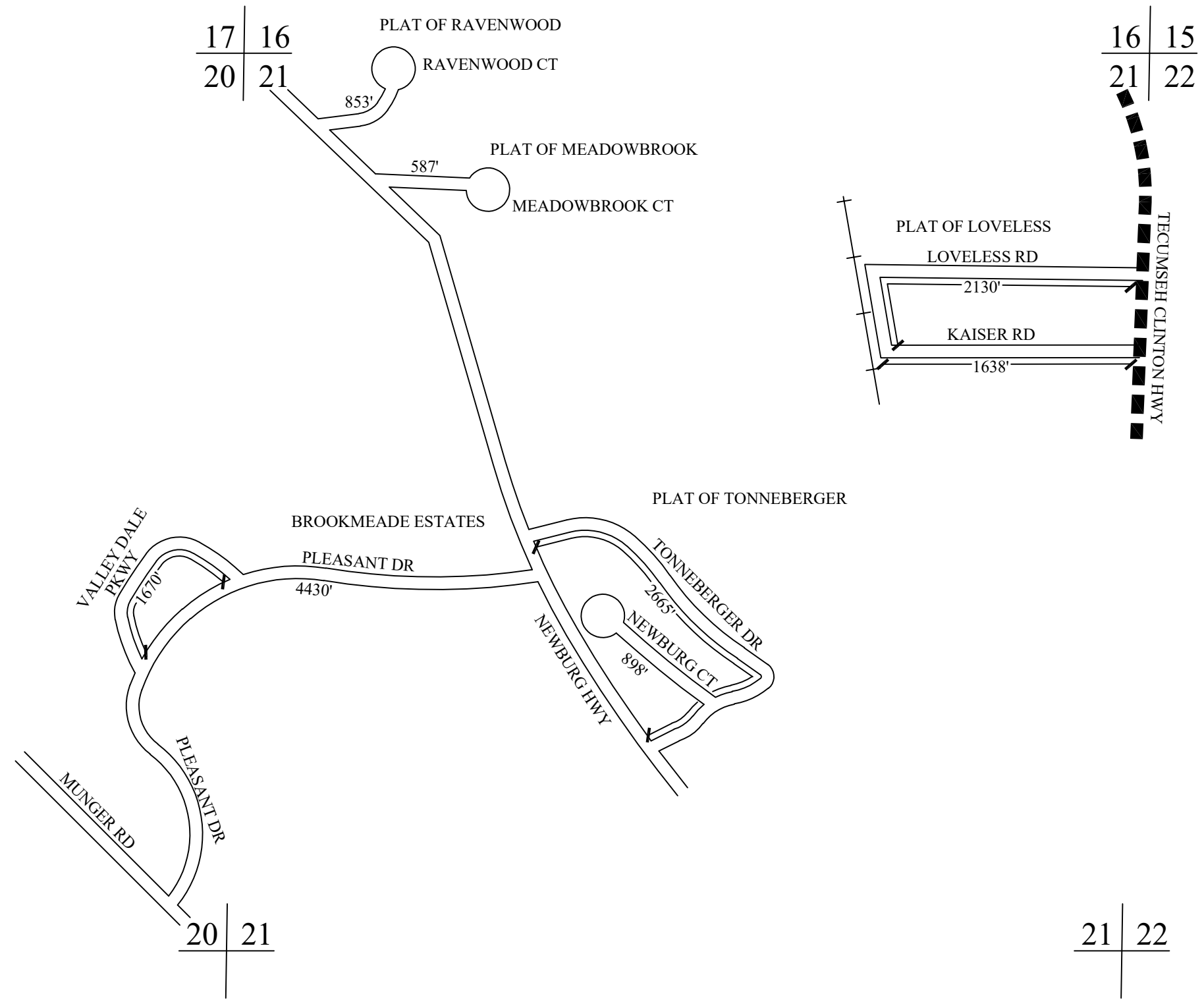

TOWNSHIP TECUMSEH
 SECTION 20 & 21 T 5S R 4E
 COUNTY LENAWEE 46

SHEET 32

- COUNTY LINE
- CORPORATE LIMITS
- STATE TRUNKLINE
- COUNTY PRIMARY
- COUNTY LOCAL
- AJACENT COUNTY
- CITY OR VILLAGE STREETS

TOTAL FEET 6054' EQUALS 1.15 MILES

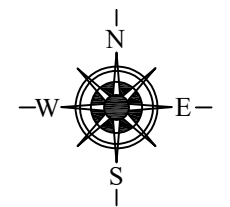
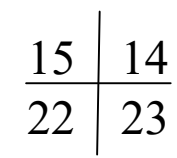
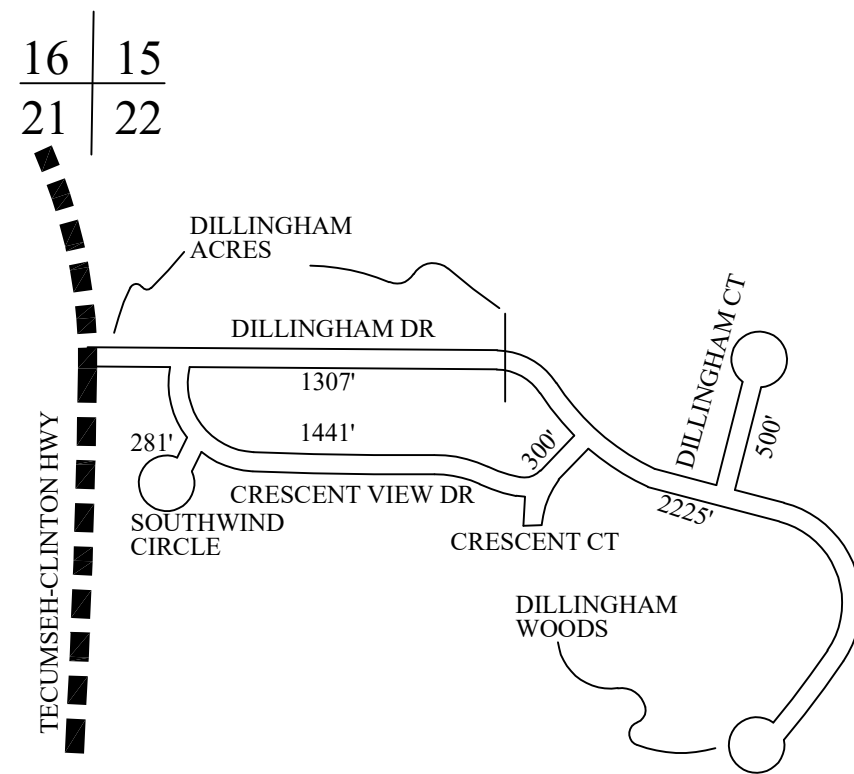

TOWNSHIP TECUMSEH
 SECTION 22 T 5S R 4E
 COUNTY LENAWEE 46

SHEET 33

- COUNTY LINE
- CORPORATE LIMITS
- STATE TRUNKLINE
- COUNTY PRIMARY
- COUNTY LOCAL
- AJACENT COUNTY
- CITY OR VILLAGE STREETS

TOTAL FEET 10,557 EQUALS 2.00 MILES

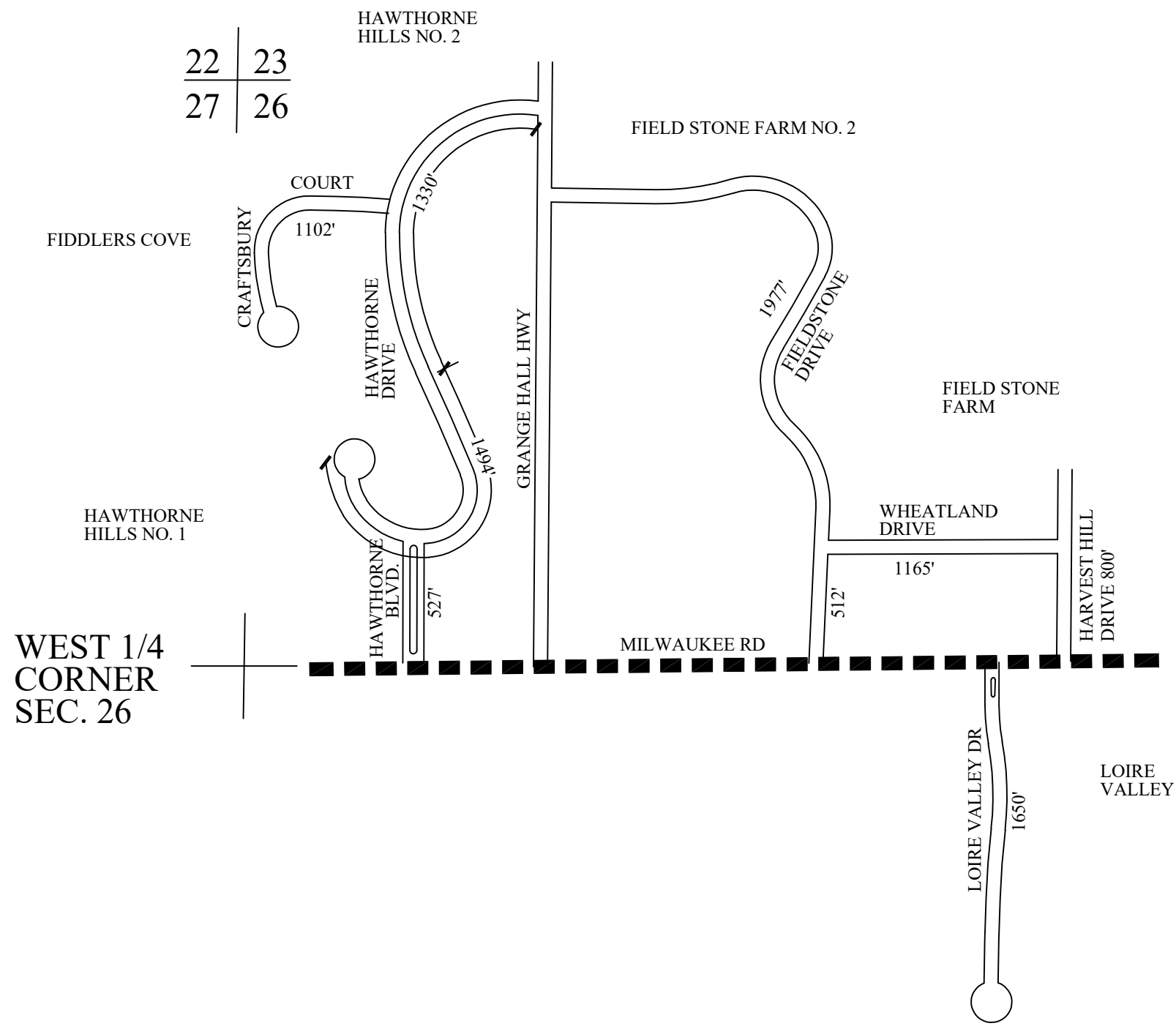

23 | 24
26 | 25

22 | 23
27 | 26

EAST 1/4
CORNER
SEC. 26

WEST 1/4
CORNER
SEC. 26

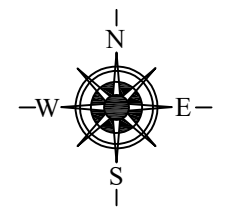

TOWNSHIP TECUMSEH
SECTION 26 T 5S R 4E
COUNTY LENAWEE 46

26 | 25
35 | 36

27 | 26
34 | 35

SHEET 34

26	25
35	36

- COUNTY LINE
- CORPORATE LIMITS
- STATE TRUNKLINE
- COUNTY PRIMARY
- COUNTY LOCAL
- AJACENT COUNTY
- CITY OR VILLAGE STREETS

TOTAL FEET 3250' EQUALS 0.62 MILES

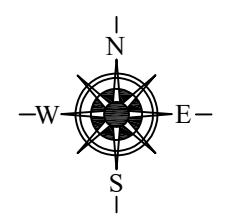
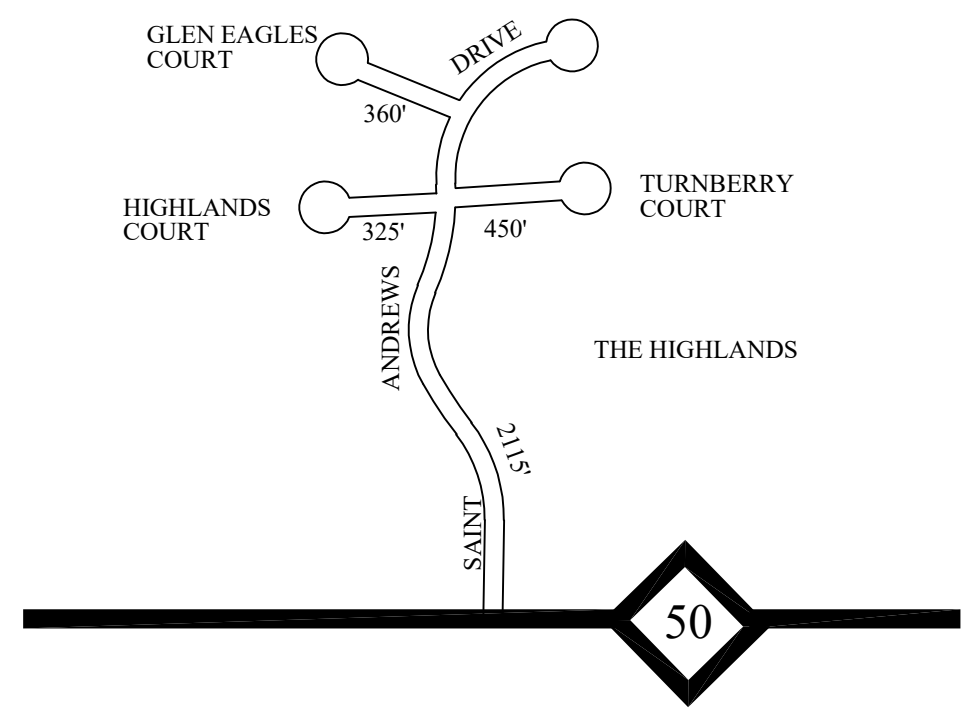

TOWNSHIP TECUMSEH
 SECTION 35 T 5S R 4E
 COUNTY LENAWEE 46

SHEET 35